

Decorative Curtain Poles





Hand Operated Curtain Pole System

Silent Gliss® 6100M Metroflat 36mm

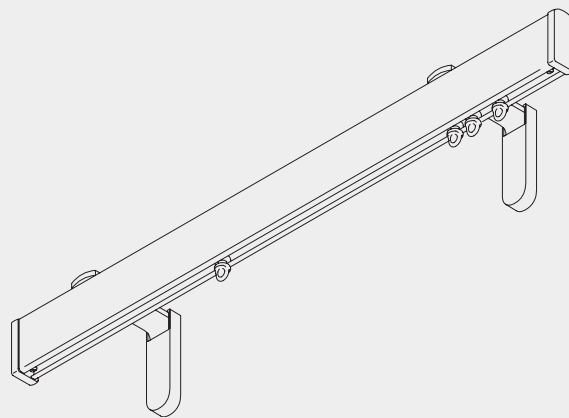

Product Information

- Hand operated system for domestic and contract applications
- Attractive contemporary appearance for modern interiors
- Can be bent to a small radius for bay windows
- Available in 7 finishes - chrome effect, silver, black, steel grey, bronze, antique bronze and gunmetal
- Accessorised with matching endcaps or glass finials
- Easy fitting to wall or ceiling
- For light to medium curtains
- Profile length 6m (chrome effect 4m)
- Suitable for Wave Standard and Wave XL curtain heading systems



6100M

Profile, Bending and Specification Information

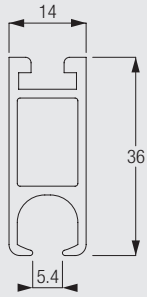

6101



Standard radius 200mm
Min. radius Wave XL: 500mm

Note: It is important to observe the above minimum bending radius for Wave XL. The system will not function with a smaller radius.

Specification Information - download from www.silentgliss.co.uk

Silent Gliss 6100M curtain track, hand drawn, aluminium, assembled complete with gliders 6143 at 10/m and 2 endcovers 0710. Ceiling fix with bracket 6138P each screwed to timber/plugged and screwed to block-work/concrete at 600mm centres. Finished in black, silver, gunmetal, bronze, antique bronze, steel grey or chrome effect.

How To Measure

Stack Size Calculation Wave Standard

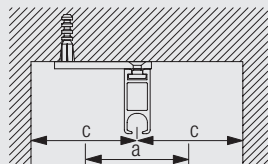
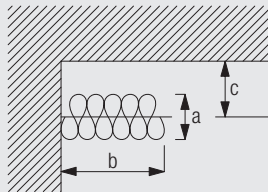

a = Stack depth
b = Stack size
c = Min. distance

| Glider-cord spacing | Curtain hook spacing | Approx. curtain fullness | Stack depth (a) | Stack width (b) | Min distance (c) |
|---------------------|----------------------|--------------------------|-----------------|----------------------------------|------------------|
| 6 | 10 | 1.9 | 10 | 23 per metre of track + endpiece | 8 |
| 6 | 12 | 2.2 | 12 | 23 per metre of track + endpiece | 9 |
| 8 | 14 | 2.0 | 14 | 18 per metre of track + endpiece | 10 |
| 8 | 16 | 2.2 | 16 | 18 per metre of track + endpiece | 11 |

Wave standard with roller gliders

| Glider-cord spacing | Curtain hook spacing | Approx. curtain fullness | Stack depth (a) | Stack width (b) | Min distance (c) |
|---------------------|----------------------|--------------------------|-----------------|----------------------------------|------------------|
| 8 | 14 | 2.0 | 14 | 21 per metre of track + endpiece | 10 |
| 8 | 16 | 2.2 | 16 | 21 per metre of track + endpiece | 11 |



(dimensions in cm)

Note: Minimum distance (c) includes a standard 3cm clearance (front and back).

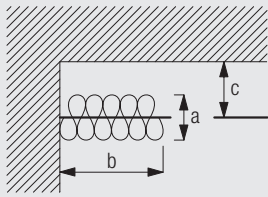
Stack size calculation Wave XL

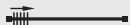

a = Stack depth 35cm
 b = Stack size
 c = Min. distance 22cm

| | | | | | | | | | | |
|---|---|---------|---------|---------|---------|---------|---------|---------|---------|---------|
| System width | | 77-107 | 108-143 | 144-179 | 180-215 | 216-251 | 252-287 | 288-323 | 324-359 | 360-395 |
|  | b | 21 | 26 | 31 | 36 | 41 | 46 | 51 | 56 | 61 |
| System width | | 396-431 | 432-468 | 469-503 | 504-539 | 540-575 | 576-600 | | | |
|  | b | 66 | 71 | 76 | 81 | 86 | 91 | | | |
| System width | | 154-217 | 218-289 | 290-361 | 362-433 | 434-505 | 506-577 | 578-600 | | |
|  | b | 21 | 26 | 31 | 36 | 41 | 46 | 51 | | |

(dimensions in cm)

Design Options

Finials

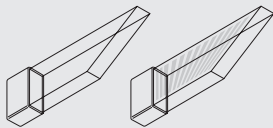
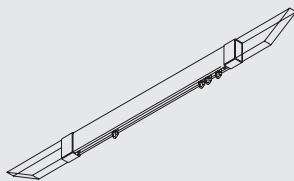

A

B

Finials are decorative elements that fix to the end of the pole.

A: 0991CL Shard (clear) 116mm
 B: 0991ET Shard (etched) 116mm

Wave Standard curtain heading system

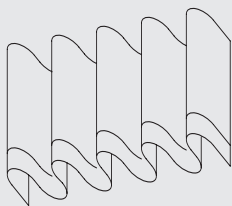

The Wave curtain heading system is an exciting contemporary curtain heading system which allows curtains to hang in a continuous wave which is smooth, simple and elegant.

When using the Wave curtain heading system please note the maximum recommended curtain weight is 2.5kg/m or 10kg/m with wave roller glider 6098W.



6100M

The Wave standard components are:

- 6345 Glider Cord 60mm
- 6346 Glider Cord 80mm
- 6007 End stop

The items listed below are all supplied at an additional cost as per the price list.

- 2255 Adjustable brake
- 6364 Extension (for use with 6365)
- 6365 Hanger (for use with 6364)
- 6366 Carrier for draw rod

Roller gliders must be ordered separately
6098W Wave roller glider 80mm

Optional enhanced components to improve the presentation of the curtain:

- 3582 Hook
- 6349 Curtain tape
- 6363 Iron-on top hemming tape
- 10075 Lead weight for bottom hem 50gr/m
- 10076 Fabric weight for side of curtain

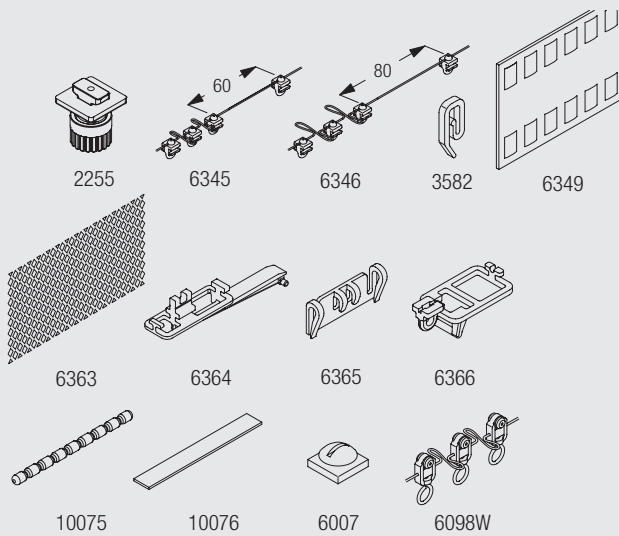

Wave XL curtain heading system

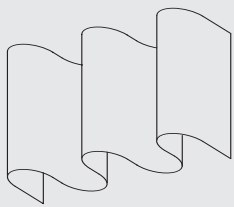

6100M

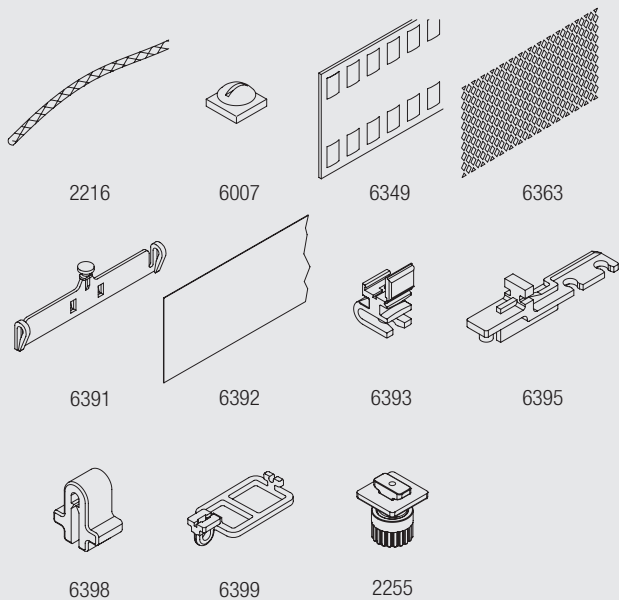

Wave XL is especially designed for high and large application areas through generously designed waves with large cross section dimensions.

The Wave XL components are:

- 2216 Cord 0.85 mm
- 2255 Adjustable brake
- 6007 End stop
- 6349 Curtain tape
- 6363 Iron tape

Fitting Information

Bracket positioning when using brackets 3134/2-3136/2



Fitting of track to brackets

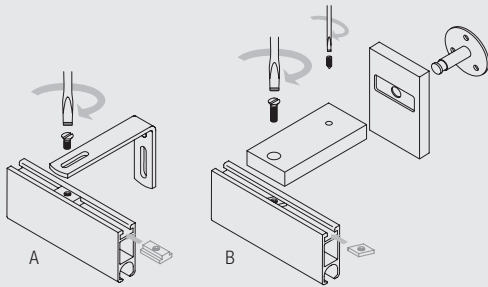

A: Using brackets 3134/2 - 3136/2
B: Using Blok brackets 0989

Fitting bent tracks.

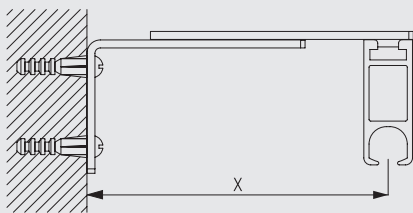

Note: all bent Metropole systems are supplied with adjustable bracket 0537 as standard.



6100M

Fitting Options

Wall fix with brackets 3134/2-3136/2

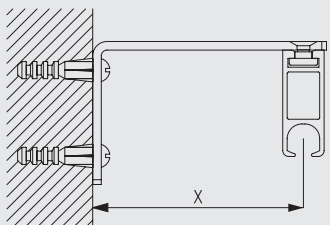

| | X (mm) |
|--------|--------|
| 3134/2 | 52 |
| 3135/2 | 72 |
| 3136/2 | 92 |

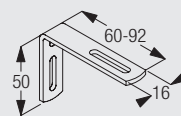

3134/2-3136/2
Extension brackets

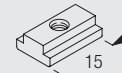

6141
Track insert (uses
screw 0798)

The final distances may be outside of the recommendations above depending on curtain heading, make-up and any obstructions.

Min. distance from wall when using Wave XL: 220mm.

Wall fix with Blok brackets 0989

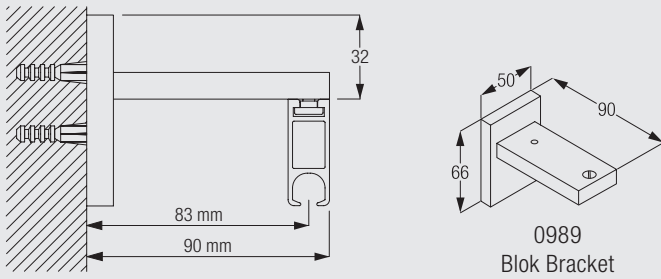

0989
Blok Bracket

The final distances may be outside of the recommendations above depending on curtain heading, make-up and any obstructions.

Min. distance from wall when using Wave XL: 220mm.

Ceiling fix with support 6138P

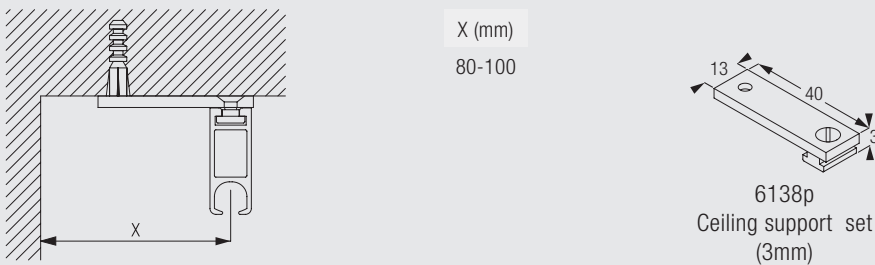

X (mm)
80-100

6138p
Ceiling support set
(3mm)

The final distances may be outside of the recommendations above depending on curtain heading, make-up and any obstructions.

Min. distance from wall when using Wave XL: 220mm.

Wall fix with adjustable bracket 0537

6100M

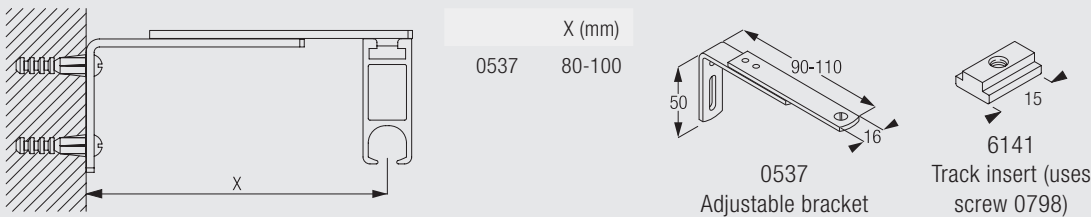

X (mm)
0537 80-100

0537
Adjustable bracket

6141
Track insert (uses
screw 0798)





The final distances may be outside of the recommendations above depending on curtain heading, make-up and any obstructions.



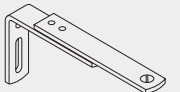

Min. distance from wall when using Wave XL: 220mm.

Note: all bent Metropole systems are supplied with adjustable brackets 0537 as standard.

Standard Accessories











Parts

| | | | | | |
|------|----------------------|---|------|--------------------------|---|
| 0537 | Adjustable bracket |  | 0710 | Endcap |  |
| 3133 | Bracket cover (60mm) |  | 3134 | Extension bracket (60mm) |  |

| | | | | | |
|------|---------------------------------|---|------|---------------------------|---|
| 6065 | Twist eye endstop |  | 6101 | Profile |  |
| 6141 | Track insert (uses screw 0798) |  | 6143 | Glider 6144 in strip form |  |
| 6784 | Machine screw (for 6141 insert) | | | | |

Optional Accessories

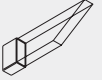









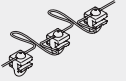

Parts

| | | | | | |
|--------|---|---|--------|--|---|
| 0989 | Blok Bracket |  | 2216 | Cord |  |
| 3582 | Hook |  | 6117 | Track insert |  |
| 6283 | Roller glider |  | 6398 | Clip |  |
| 3135/2 | Pole extension bracket (80mm - all colours) |  | 3136/2 | Pole extension bracket (100mm - all colours) |  |
| 6138p | Ceiling support set (3mm) |  | 0991CL | Shard Clear Metroflat |  |
| 0991ET | Shard Etched Metroflat |  | | | |

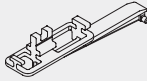

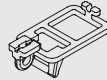
6100M

Wave Accessories

| | | | | | |
|------|---------------------------|---|------|-------------------------|---|
| 2216 | Cord |  | 2255 | Adjustable brake |  |
| 3582 | Hook |  | 6007 | Endstop |  |
| 6345 | Wave glider cord (60mm) |  | 6346 | Wave glider cord (80mm) |  |
| 6349 | Wave curtain heading tape |  | 6363 | Top hemming tape |  |
| 6364 | Extension |  | 6365 | Hanger |  |
| 6366 | Wave carrier for draw rod |  | 6391 | Hanger |  |
| 6392 | Heading film |  | 6393 | Glider |  |

6395 Extension



6398 Clip



6399 Carrier for Draw rod

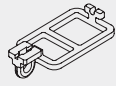

10075 Lead weight 50 gr/m



10076 Fabric weight



6098W Wave roller glider cord (80mm)

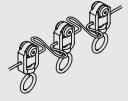

6100M



6100M

www.silentgliss.co.uk

www.silentglissglobal.com

Silent Gliss Ltd
Pyramid Business Park
Poorhole Lane
Broadstairs
Kent
CT10 2PT
Great Britain

Tel: +44 (0) 1843 863571
Fax: +44 (0) 1843 864503
info@silentgliss.co.uk

Silent Gliss Global Ltd
Pyramid Business Park
Poorhole Lane
Broadstairs
Kent
CT10 2PT
Great Britain

Tel: +44 (0) 1843 874250
Fax: +44 (0) 1843 874457
info@silentglissglobal.com